



VAIS TECHNOLOGY

www.vaistech.com

Owner's Manual

MultiMediaLinQ

Model :VML

Automotive Audio Player
with USB 2.0 Host
and optional HDD

Now
with iPod USB Audio and Controls

TOYOTA • LEXUS • SCION

 WARNING**DO NOT DISASSEMBLE OR ALTER**

Doing so may result in an accident, fire or electric shock.

Do not block your view

Do not mount product or any added audio and/or video equipment where it can block your view through the windshield or your view of dashboard indicators and displays.

Do not block the airbag

Do not mount product or any added audio and/or video equipment where it can obstruct the operation of the safety device such as the airbag.

Distraction warning

Do not let product or any added audio and/or video equipment to distract you while you are driving.

BEFORE WIRING, DISCONNECT THE CABLE FROM THE NEGATIVE BATTERY TERMINAL

Before starting any installation work, you must wait 90 seconds after turning the ignition switch to the LOCK position and disconnecting the negative (-) terminal from the battery. The supplemental restraint system (airbag) is equipped with a backup power source. If installation work is started less than 90 seconds after disconnection of the negative (-) battery terminal, the SRS may deploy. When the negative (-) terminal cable is disconnected from the battery, the clock and audio systems memory will be erased. Before starting installation work, make a record of the clock and audio systems memory settings. When installation is complete, reset the clock and audio systems to their previous settings. Power tilt, power telescopic steering column, front power seats, power mirrors, and power shoulder belt anchorage are equipped with a memory function. The rear power seat is not equipped with a memory function, and they can make a record of the memory contents, rear power seat is not equipped with the memory function. When installation is complete, it is necessary to readjust the features to their previous settings. Never use a backup power supply (such as another battery) during installation work to avoid losing these memory settings.

 CAUTION**DO NOT SPLICE INTO ELECTRICAL CABLES**

Never cut away cable insulation to supply power to other equipment. Doing so will exceed the current carrying capacity of the wire and result in fire or electric shock.

DO NOT ALLOW CABLES TO BECOME ENTANGLED IN SURROUNDING OBJECTS

Cables or wiring that obstruct or get caught on places such as the steering wheel, shift lever, brake pedals, etc. can be extremely hazardous.

DO NOT INSTALL IN LOCATIONS WITH HIGH MOISTURE OR DUST

Moisture or dust may result in product failure.

HAVE THE WIRING AND INSTALLATION DONE BY EXPERTS

The wiring and installation of this product requires special technical skills and experience.

USE ONLY SPECIFIED ACCESSORY PARTS

Use of other than specified parts may damage product internally.

FOLLOW THE OPERATIONAL AND INSTALLATION MANUALS.

YOU SHOULD READ AND FAMILIARIZE YOURSELF THOROUGHLY WITH THE FOLLOWING INFORMATION PRIOR TO INSTALLING AND USING THIS UNIT. IN ADDITION, YOU MUST CAREFULLY READ AND FOLLOW THE INSTALLATION SCHEMATICS/INSTRUCTIONS FOR THE PRODUCT AND THE VEHICLE IN WHICH IT IS BEING INSTALLED. FAILURE TO FOLLOW INSTALLATION INSTRUCTIONS MAY DAMAGE THE PRODUCT AND THE VEHICLE, WILL VOID THE PRODUCT WARRANTY, AND MAY VOID THE VEHICLE WARRANTY

CHECK YOUR LOCAL LAWS

Some States/Provinces or other governmental jurisdictions (such as cities) may have laws that prohibit the operation of a video screen within the sight of the Driver. If you have purchased such a product, you should use the product only in locations where it is legal to do so, and if you do use the product, set up the screen so it is only visible to passengers.

TROUBLESHOOTING

Should this product fail to operate properly, please contact your Dealer or our Customer Service Department at support@vaistech.com.

i IMPORTANT

The VML Audio Player supports playback of MP3 and WAV files from a USB Mass Storage Device or optional automotive grade internal Hard Drive (see details below).

i What is MP3?

MP3 (MPEG-1 Audio Layer 3) is a digital audio encoding format using a form of lossy data compression. "MPEG Layer 3 audio coding technology licensed from Fraunhofer IIS and Thomson."

"Supply of this product only conveys a license for private, non-commercial use and does not convey a license nor imply any right to use this product in any commercial (i.e. revenue-generating) real time broadcasting (terrestrial, satellite, cable and/or any other media), broadcasting/streaming via internet, intranets and/or other networks or in other electronic content distribution systems, such as pay-audio or audio-on-demand applications. An independent license for such use is required. For details, please visit <http://www.mp3licensing.com>."

i Audio Format Compatibility**MP3**

- Bit rate: 8 kbps to 320 kbps
- Sampling frequency: 16 kHz to 48 kHz
- Compatible ID3 tag version: 1.0, 1.1, 2.2, 2.3, 2.4 (ID3 tag Version 2.x is given priority over Version 1.x.)
- M3u playlist: Supported
- MP3 PRO: Not supported

WAV

- Compatible format: Linear PCM (LPCM)
- Quantization bits: 8, 16, 24 and 32 (LPCM)
- Sampling frequency: 16 kHz to 48 kHz (LPCM)

i USB Memory/Portable Audio Player Handling

- This unit can playback files in USB memory and USB Portable Audio Players that support the USB Mass Storage Class (MSC) protocol.
- You cannot connect a USB memory or USB Portable Audio Player to this unit via a USB hub.
- Partitioned USB memory is compatible with this unit. (Can not be managed by Windows XP and Windows Vista).
- Depending on the kind of USB memory or USB Portable Audio Player, this unit may not recognize the USB memory or USB Audio Player and/or audio files may not be played back properly.
- USB memory devices with security functions can not be played (for example Flash drive with Hardware encryption).
- USB memory or USB Audio Player may not function correctly at high or low temperature.
- Do not leave the USB memory or USB Audio Player in direct sunlight for extended amounts of time. It can result in USB memory or USB Audio Player malfunction.
- USB memory or USB Audio Player may take time to playback. Depending on amount of files and specific file location in the memory, it may take considerable time before the file is played back.
- Never remove USB memory or USB Audio Player device while playback or file transfers are in progress, to prevent possible damage to its memory (see "How to eject a USB device").
- Never insert/remove USB memory or USB Audio Player while vehicle is in motion for safety.
- USB memory or USB Portable Audio Player must be formatted as FAT16 or FAT32.
- Unit can playback up to 999[●] playlists and up to 999 files in each playlist (per partition). Large amount of playlists and files can result in slow navigation and playback.
- For USB memory or USB Portable Audio Player VML player supports MPEG-1 Layer 1 (file extension .MP1), MPEG-1 Layer 2 (file extension .MP2) and the MPEG-2 audio extension to Lower Sampling Frequencies.
- File extensions must be used properly (non-audio data will not be recognized). Playback of non-audio data may generate a noise that can cause damage of amplifier and/or speakers.
- You must maintain "Free Space" on USB memory or USB Portable Audio Player necessary for unit operation (approximately 1% of partition capacity).
- Touching the connector terminals may transmit static electricity to the inner circuits of unit or USB memory/USB Portable Audio Player and may lead to malfunctions. Use precautions to prevent damage to the system by electrostatic discharge (ESD).
- If iPod connected to VML player, supports USB Audio, VML player will switch to dedicated iPod control mode. In that case VML player will not use Mass Storage capabilities of the iPod.

[●] - VML can playback up to 999 playlists in CD-MP3 emulation mode and up to 99 playlist in CD changer or MD changer emulation mode.

i Internal Hard Drive Handling

- This unit can playback files from the optional internal IDE Hard Disc Drive (HDD).
- HDD playback functionality requires additional activation.
- HDD playback functionality will be automatically de-activated after 5 failed attempts to recognize HDD.
- Unit can recognize up to 4 Primary Partitions accessible as separate Discs.
- Depending on amount of files and specific file location, it may take considerable time before the file is played back.
- Never remove or hot-swap HDD while unit is powered to prevent possible damage of HDD and/or VML player itself.
- HDD must be formatted as FAT16 or FAT32.
- Unit can playback up to 999⁹ playlists and up to 999 files in each playlist (per partition). Large amount of playlists and files can result in slow navigation and playback.
- For HDD VML player supports MPEG-1 Layer 1 (file extension .MP1), MPEG-1 Layer 2 (file extension .MP2) and the MPEG-2 audio extension to Lower Sampling Frequencies.
- File extensions must be used properly (non-audio data will not be recognized). Playback of non-audio data may generate a noise that can cause damage of amplifier and/or speakers.
- You must maintain "Free Space" on HDD necessary for unit operation (approximately 1% of partition capacity).
- Be sure HDD has enough free space to complete file transfer.
- Touching the connector terminals may transmit static electricity to the inner circuits of unit or HDD and may lead to malfunctions. Use precautions to prevent damage to the system by electrostatic discharge (ESD).
- To avoid condensation that can lead to HDD permanent damage do not introduce HDD or unit with HDD inside to sudden temperature changes. If transferring HDD or unit with HDD inside always allow it some time to adopt to the surrounding environment.
- Never touch top cover of HDD. Always hold HDD on the sides. Follow the Hard Drive Manufacturer handling instructions.
- Keep HDD or unit with HDD inside away from magnetic items.

i IMPORTANT

- To prevent the accidental loss of data, we are strongly recommend always backing up important data on your computer.
- VAIS Technology accepts no responsibility for any loss of data on USB memory/USB Portable Audio Player and/or HDD, even if data is lost while using this unit.
- This unit does not support connections to a computer.

i IMPORTANT**Important Please Read!**

(1) After a delay of five seconds, this product will automatically bypass the automobile manufacturer's on-screen warnings concerning use of the onboard navigation system. These warnings are: "Caution, Drive safely and obey traffic rules. Watching this screen while vehicle is in motion can lead to a serious accident. Make selections only while stopped. Some map data may be incorrect. Read safety instructions in Navigation Manual."

(2) PLEASE PRE-NOTIFY EVERY DRIVER OF THIS VEHICLE OF THE CONTENT OF THE AUTOMOBILE MANUFACTURER'S WARNING.

(3) IF YOU PREFER THAT THIS PRODUCT NOT ELIMINATE THE FOREGOING WARNINGS, YOU MAY DISABLE THIS FEATURE BY FOLLOWING THE INSTRUCTIONS IN THIS OWNER'S MANUAL, OR REFER TO INSTRUCTIONS AVAILABLE ON THE MANUFACTURER'S WEBSITE WWW.VAISTECH.COM.

i Storage device requirements

- Unit can recognize up to 4 Primary Partitions accessible as a separate Discs.
- Storage must be formatted as FAT16 or FAT32.
- You must maintain "Free Space" on HDD necessary for unit operation (approximately 1% of partition capacity).
- VML player doesn't support full path names of more than 255 characters.
- FOR M3U FILES ONLY: You must use UTF-8 encoding. Line length for M3U file CAN NOT exceed 255 UTF-8 symbols.

i Recommendations and explanations

- Playlist name, album name, artist name, song title and all other text information is limited by vehicle Radio to display 26 characters only. Some vehicles are limited to 16 characters. We recommend creating unique playlist name, album name, artist name, song title, and etc. for easier navigation through VML player.
- FOR MP3 FILES ONLY: VML player takes song title, album name, artist name, and etc. from ID3 tag data container.
- If song title ID3 Tag does not exist or is empty, VML player will generate song title from the MP3 file name. Please make sure your file name is unique within 26 character limitation described above.
- FOR WAV FILES ONLY: Song title is generated from WAV file name. Please make sure your file name is unique within 26 character limitation described above.
- We strongly recommend using ASCII symbols from table, Tab 1. If you use any other symbol not in Tab1, VML player will automatically change it to "**".

	0	1	2	3	4	5	6	7
0			space	0	@	P	`	p
1			!	1	A	Q	a	q
2			“	2	B	R	b	r
3			#	3	C	S	c	s
4			\$	4	D	T	d	t
5			%	5	E	U	e	u
6			&	6	F	V	f	v
7			'	7	G	W	g	w
8			(8	H	X	h	x
9)	9	I	Y	I	y
A			*	:	J	Z	j	z
B			+	;	K	[k	{
C			,	<	L	\	l	
D			-	=	M]	m	}
E			.	>	N	^	n	~
F			/	?	O	_	o	del

Tab 1.
ASCII symbols

i Storage device requirements

- ▶ Unit can recognize up to 4 Primary Partitions accessible as separate Discs.
- ▶ Storage must be formatted as FAT16 or FAT32.
- ▶ You must maintain "Free Space" on HDD necessary for unit operation (approximately 1% of partition capacity).
- ▶ VML player doesn't support full path names of more than 255 characters.
- ▶ FOR M3U FILES ONLY: You must use UTF-8 encoding. Line length for M3U file CAN NOT exceed 255 UTF-8 symbols.

i Media Files location

SCENARIO 1

"M3U playlists files"

PRIORITY 1

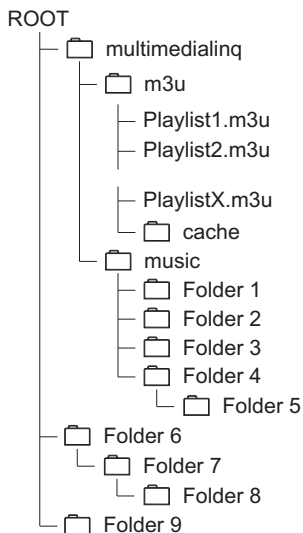

SCENARIO 2

"MultiMediaLinQ Music Folder"

PRIORITY 2

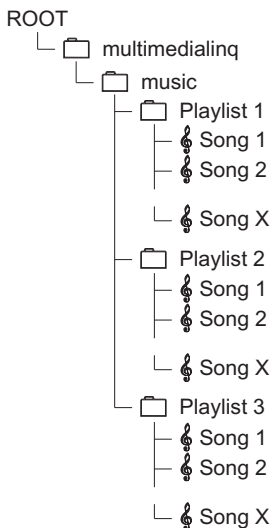

SCENARIO 3

"ROOT Music Folders"

PRIORITY 3

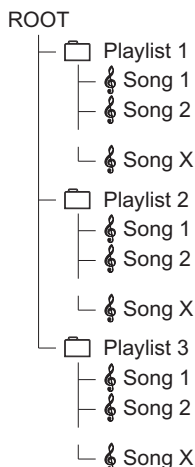

i VML Player behavior depends on media file location

- ▶ If the M3U folder is empty or no valid M3U files are found then VML player will check for the last used "folder based" scenario (scenario 2 or scenario 3). If that information is not found or corrupted, then VML player will try to switch to scenario 2. If according to scenario 2 there are no folders with music files in multimedialinq/music folder then VML will switch to scenario 3.
- ▶ If according to scenario 3 there are no folders with music files in the ROOT folder then VML player will mark this disc unavailable and will switch to the next available disc if it exists.

i Media Files location (SCENARIO 1)

SCENARIO 1

"M3U playlists files"

PRIORITY 1

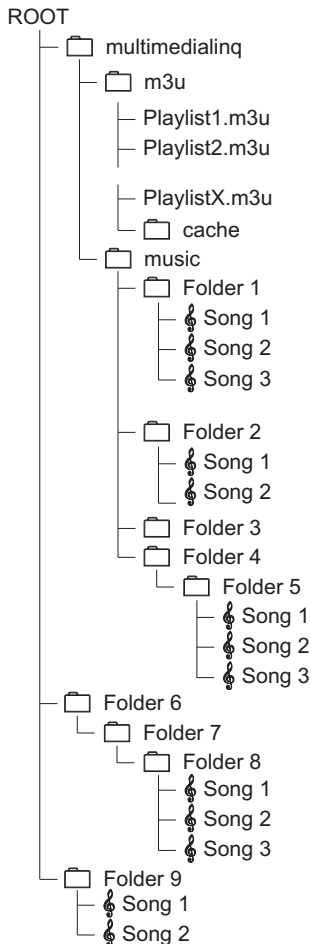

VML Player will create playlists based on M3U files with ".m3u" extension located in folder "[ROOT]/multimedialinq/m3u/". VML Player accepts playlist's file name as playlist's name (up to 41 characters*). VML player supports up to 999● playlists ("m3u files") and up to 999 media files per playlist file. "m3u" files use the UTF8 encoding.

NEW: VML Player will create list of ARTISTS based on M3U files with ".m3u" extension located in folder "[ROOT]/multimedialinq/m3u.Artist/".

NEW: VML Player will create list of ALBUMS based on M3U files with ".m3u" extension located in folder "[ROOT]/multimedialinq/m3u.Album/".

An M3U file is a plain text file that contains the locations of one or more media files that the VML Player should include in a playlist. Each location is placed on a new line. The locations should be absolute "UNIX style" path names (e.g., "multimedialinq/music/PL1/song1.mp3") or "Windows style" path names (e.g., "multimedialinq/music/PL1\song1.mp3"). M3U file also can contain comments prefaced by the "#" character.

Media file can be located anywhere on the same disc where the M3U file is located, but recommended to organize your media files in such a way that the pathnames are as short as possible.

M3U file example

```
#####
/multimedialinq/music/Folder1/Song1.mp3
/multimedialinq/music/Folder4/Folder5/song3.mp3
/multimedialinq/music/Folder1/Song2.mp3
/multimedialinq/music/Folder2/Song1.mp3
/Folder6/Folder7/Folder8/Song3.mp3
/multimedialinq/music/Folder2/Song2.mp3
/multimedialinq/music/Folder4/Folder5/Song1.mp3
/Folder6/Folder7/Folder8/Song1.mp3
/Folder9/Song2.mp3
/Folder9/Song1.mp3
#####
```

Playlists will be created in the order of the M3U files physical location in the m3u folder. Media files will be organized according to their place in the M3U file.

! WARNING

*VML player accepts playlist's file name as playlist's name. Playlist's file name can contain up to 41 characters plus file extension, but will only display 26 characters due to radio limitation. (Some Radios can only support 16 characters).

Make sure to create unique playlist file names to be able to recognize your playlists during browsing.

You must use UTF-8 encoding. Line length for M3U file CAN NOT exceed 255 UTF-8 symbols.

To create M3U files we recommend using third party software such as

"ADVANCED MP3 CATALOG" (<http://www.wizetech.com>)

"WINAMP" player (<http://www.winamp.com>)

and etc.

Make sure to use UTF-8 encoding when creating M3U files. The file extension must be M3U and not M3U8.

i Media Files location (SCENARIO 2)**SCENARIO 2**

"MultiMediaLinQ Music Folder"

PRIORITY 2

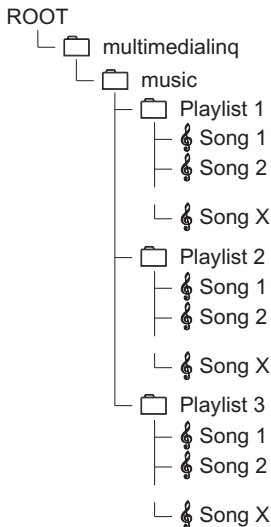

Location: "[ROOT]/multimedialinq/music"

VML Player will create playlists based on first-level subfolders in the MultiMediaLinQ Music Folder. VML Player accepts the subfolder's name as the playlist's name. Folder's name has no limitation on characters count, as long as the full path name with file name does not exceed 255 characters. VML player will only use the first 26 characters to create the playlist name. In this case the playlist name with up to 26 characters will be displayed on your Radio, but please keep in mind some Radios can only display 16 characters. Make sure to create unique folder names to be able to recognize your playlists during browsing.

VML Player supports up to 999[●] playlists (subfolders) and up to 999 media files per Playlist (subfolder).

Example:

```

"[ROOT]\multimedialinq\music\PlaylistName1\[MP3/WAV media files]"
"[ROOT]\multimedialinq\music\PlaylistName2\[MP3/WAV media files]"
  
```

Media files have to be located directly in [Playlist] subfolders to be played by VML Player. Files located in a playlist's nested subfolders are not supported. Playlists will be created in order of their physical location in the music folder. Media files will be organized in order of their physical location in the playlist folder.

NOTE

If VML Player detects that the Mass Storage Device is iPod, it will assume that source music folder is folder "/iPod_Control/Music". Since the iPod's folders names are not informative, it's recommended to use mode "M3U playlists files".

i Media Files location (SCENARIO 3)**SCENARIO 3**

"ROOT Music Folders"

PRIORITY 3



VML Player will create playlists based on first-level subfolders in partion's root folder. VML Player accepts the subfolder's name as the playlist's name. The Folder's name has no limitation on characters count, as long as the full path name with file name does not exceed 255 characters. VML player will only use the first 26 characters to create the playlist name. In this case the playlist name with up to 26 characters will be displayed on your Radio, but please keep in mind some Radios can only display 16 characters. Make sure to create unique folder names to be able to recognize your playlists during browsing.

VML Player supports up to 999[●] playlists (subfolders) and up to 999 media files per playlist (subfolder).

Example:

```

"[ROOT]/PlaylistName1/[MP3/WAV media files]"
"[ROOT]/PlaylistName2/[MP3/WAV media files]"
  
```

Media files have to be located directly in [Playlist] subfolders to be played by VML Player. Files located in a playlist's nested subfolders are not supported.

Playlists will be created in order of their physical location in the music folder. Media files will be organized in order of their physical location in the playlist folder.

VML Player Internal Data Structure

VML Player stores all internal data in the folder "multimedialinq". If that folder is not present on a playable partition, player will create the folder. Folder structure:

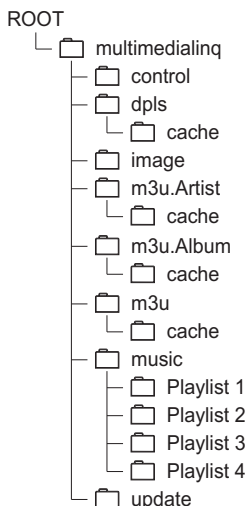

- **Folder "control" (CONTROL)**
Player will check this folder for CMD file "mmlqcmdf.cmd" to add, modify or remove data on internal HDD;
- **Folder "dpls" (DPLS)**
Player will use the folder for storing the "folder-based playlists" CACHE files (modes 1 or 2). File "dpls_cache.pdb" is playlists CACHE file that contains information about last used "folder-based" operational mode and list of playlists. Subfolder "cache" contains CACHE files (extension "m3uV") for each detected playlist;
- **Folder "image"**
Player will create/use the folder for storing "Storage image" files if such image was requested in CMD file;
- **Folder "m3u" (M3U)**
Player will check the folder for M3U playlists files and will use it to store CACHE files in Scenario 1. Subfolder "cache" contains playlist's CACHE files (extension "m3uV");
- **Folder "m3u.Artist" (M3U.ARTIST)**
Player will check the folder for M3U playlists files for category "Artist" and will use it to store CACHE files in Scenario 1. Subfolder "cache" contains playlist's CACHE files (extension "m3uV");
- **Folder "m3u.Album" (M3U.ALBUM)**
Player will check the folder for M3U playlists files for category "Album" and will use it to store CACHE files in Scenario 1. Subfolder "cache" contains playlist's CACHE files (extension "m3uV");
- **Folder "music" (MUSIC)**
Recommended location for AUDIO files. It's recommended to organize audio information according to the description in Scenario 2 "VML Music Folder";
- **Folder "update"**
Player will check the folder for software updates;

VML Player and Data "CACHING" Mechanism

VML player has been designed to incorporate a caching mechanism.

Every folder and playlist will be pre-processed by VML player and it will create corresponding cache file/s with a list of songs in the dpls/cache folder (for scenario 2 and scenario 3) to improve VML browsing and playback performance. For scenario 1, cache file/s will be created in the M3U/cache folder.

VML player will also create an additional cache file "dpls_cache.pdb" with a list of folders/playlists in the dpls folder, available for scenario 2 and 3.

Add/Remove Music Files Manually:



Cache files have priority over original music data. If original data has been changed or re-created* in at least one folder or M3U playlist file depending on the scenario used, then you must remove the corresponding cache files to make sure VML player re-builds the cache. You can remove either one or all files in the cache folder to force VML player to re-build the cache. We strongly recommend to delete the cache files associated with the changes only. Removing all files from the cache folder will force VML player to re-build all cache files on this particular disc, which will slow down VML performance dramatically.

Add/Remove Music Folders Manually:



The cache file "dpls_cache.pdb" has priority over original music data. If the original data has been changed, for example one folder has been added, removed, or re-created*, then you must remove "dpls_cache.pdb".

* File or folder was first removed and then created again with the same name.

VML player constantly verifies the cache files against non-existing or non-supported files and folders during operation in background mode. If it detects a certain amount of bad links, it will try to re-build on the first attempt and will mark unavailable for playback on the second attempt.

***i* How to Eject a USB device?**

Simply push the "SCAN" button twice in one second and then immediately push the "PWR" button on your radio. On some radios the "PWR" button is combined with "VOL" knob.

Message "Ejecting USB. Please wait" is displayed to confirm you can safely remove the USB device. Do not remove USB storage while the device is being accessed, as it may result in loss of data.

When Accessory of your vehicle is turned OFF, the USB device will be automatically disconnected (unmounted).

***🔧* NOTE**

Never remove USB memory or USB Audio Player device while playback or file transfer is in progress, to prevent possible damage to its memory. VAIS Technology is not responsible for any lost or damaged data on storage media.

***i* VML Player Software Updates**

Please check the website for VML Player software updates. Update file is always named "mmlq_upd.bin" and must be placed in UPDATE folder "/multimedialinq/update" on the device's first FAT16/FAT32 partition. VML Player will check the UPDATE folder if updates are available. If the update is verified and approved, the VML player will stop playback and initiate the update sequence. During the update the VML player will always restart. After the update is done, the update file will be removed from the source.

***🔧* NOTE**

Update may require 2 steps. Please follow the instructions provided with the update.

***i* How to adjust sound level (gain) of MP3 files?**

Due to different algorithms used to create MP3 files, sound level may vary. Before putting your songs onto the USB storage or HDD, we recommend using MP3Gain- free cross-platform software to adjust sound level to the same perceived volume.

<http://sourceforge.net/projects/mp3gain/>

***i* How to check VML player Software/Firmware version**

Software/Firmware version is displayed in SETTINGS Mode.

- To put your device in SETTINGS Mode rapidly press the [SCAN] button 8 times (MUST BE DONE within 1-2 seconds).
- To exit SETTINGS Mode rapidly press the [SCAN] button 8 times (MUST BE DONE within 1-2 seconds).

i VML Player operational notice

- ▶ For scenario 2 and 3 files and folders will be available in the VML player in the order they were recorded on the disc, which is not always the same order files are located and displayed on your PC.
- ▶ VML player will recognize all available folders (including empty and non-playable information folders) on the first USB storage/HDD connection or if playlists cache information is not available or erased. Once playlist's cache files are built and the system has been restarted, VML player will display playable information only.

Connecting USB device:

- ▶ VML player analyzes a USB device for playable partitions every time it's plugged into VML player. VML supports up to 4 partitions per USB storage device and 6 partitions total.
- ▶ The vehicle's Radio recognizes every partition as a separate disc.
- ▶ Non-playable partitions will not be recognized by VML player.
- ▶ If at the time you connect USB storage, VML player is playing audio files from a HDD, VML player will recognize the USB storage device but will continue playing HDD files. The USB storage device becomes available as a source shortly after connection, as an additional DISC. If USB storage is the only one available source, then VML player will play it automatically.

Disconnecting USB device:

- ▶ Please follow our recommendation on "How to eject a USB device".
- ▶ If USB Storage is the only connected device to VML player then once it is ejected VML player will stop playing and will wait for the next available USB Storage device.
- ▶ If USB Storage as well as a HDD are connected to VML player and USB Storage is currently playing, disconnecting of the USB Storage device will force VML player to start playing the first available HDD partition.

Disc Loading:

- ▶ While loading discs VML player will flash the first disc until all available discs are detected. Once all available discs are detected VML player will make them available for selection.
- ▶ If a disc is selected but it is not ready to play, VML player will flash this disc until it's fully processed or a reasonable amount of information is processed. VML player will start playing even if processing is not over for this disc as long as a reasonable amount of information has been processed. Playlists become available for browsing as they are processed on the disc.
- ▶ After a reasonable amount of information has been processed and a disc starts playing processed playlists, VML player will flash a SCAN button to notify you that the rest of the playlists are still being processed.
- ▶ If a substantial amount of errors (bad or non-existing files) are detected on the disc, VML player may start the re-building process automatically, which will make this disc flash until it is ready to play.

i How to Copy files to HDD

- ▶ In order to load audio files and/or M3U files to a HDD you need to put those files on USB storage first, along with "mmlqcmdf.cmd" file. The "mmlqcmdf.cmd" file must be located in the "/multimedialinq/control/" folder. It must be located on the first FAT16/FAT32 partition if more than one is available.
- ▶ The command file "mmlqcmdf.cmd" file contains a list of commands to add/remove/modify data on the internal HDD.
- ▶ To create/modify command file please use "Remote Storage Manager" software on our website www.vaistech.com/software/RSMManager.exe
- ▶ Command file processing will start after all available discs are ready and verified. Command file processing is executed in background mode.
- ▶ If changes in the command file are critical for playing music files from HDD, VML player will make this disc unavailable for play.
- ▶ If changes in the command file are not critical then VML player will make the changes, but will only make those changes available after the command file is executed and source is completely re-built. Since the re-building process could take some time, command file changes may not be available immediately. The SCAN button will flash during the re-building process.
- ▶ Command file processing may be interrupted and resumed if file hasn't been changed.

Connecting MultiMediaLinQ

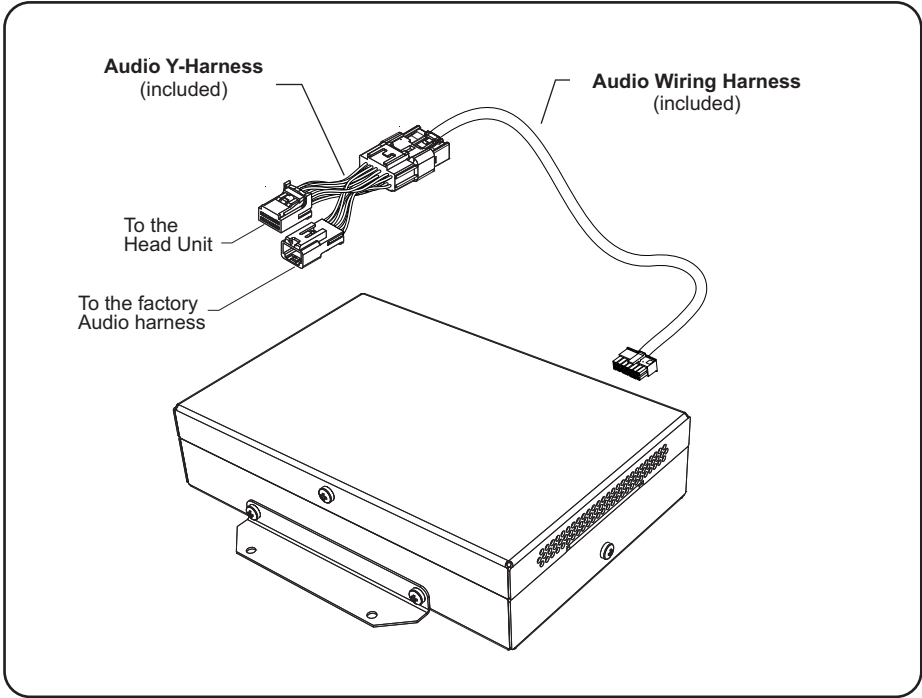

Connecting the units

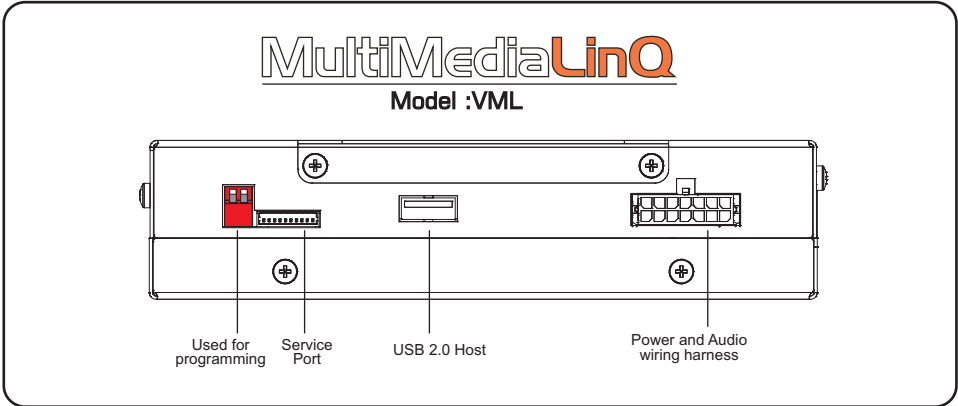

Connecting MultiMediaLinQ to head unit (for Lexus vehicles 01-04)

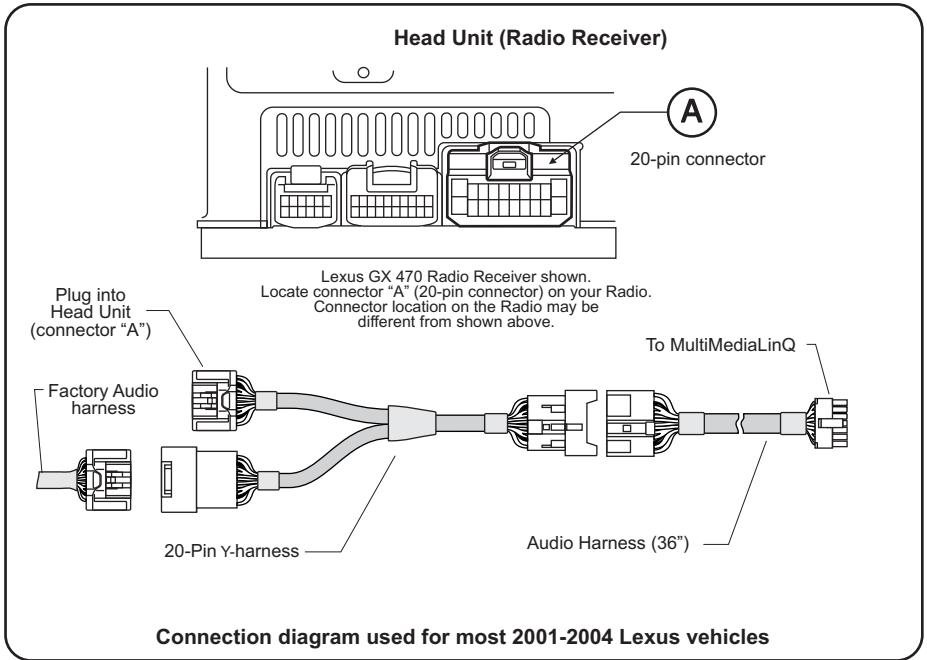

Connecting MultiMediaLinQ to head unit (for Toyota/Lexus vehicles)

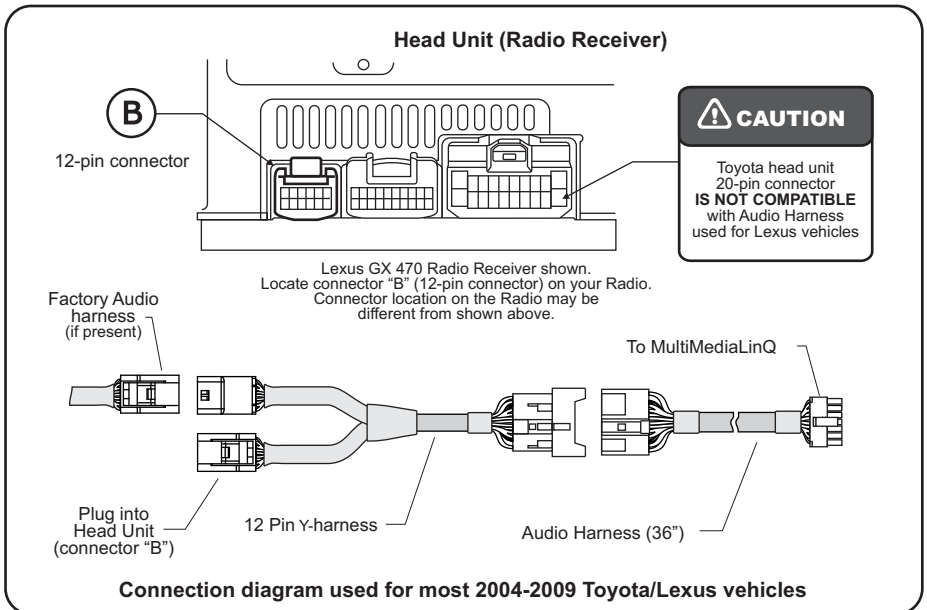

WARNING

To Un-plug any connector do NOT pull it by the wires.

i IMPORTANT

We strongly recommend that you install the unit in an easily accessible location, so you can later upgrade the unit or re-program it in case of incorrect programming.

Installation

- ... Gain access to the back of you vehicle's Head Unit.
- ... Find the same port as our Audio Harness (see "Connecting MultiMediaLinQ to head unit")
- ... Disconnect the existing connector and plug in our Audio connector into this port, then plug female end of Audio Harness to the plug in for your factory connector. Audio harness female connector is not used In some vehicles.
- ... Plug the other end of Audio cable into designated port on MultiMediaLinQ.
- ... Setup proper Emulation Mode for this unit (see "Emulation Mode Selection")
- ... Turn the car on and check MultiMediaLinQ functionality (especially Text capability) before the final assembly.
- ... Make sure your USB Storage device has at least two Folders/playlists, in order for this unit to operate properly.
- ... Please mount this unit in an easy accessible location for upgrading and re-programming purposes.
- ... Secure the Head Unit in its original position.

Emulation Mode Selection

MD Changer Emulation Mode programming steps:

- ... Properly install VML player.
- ... Put both programming switches in "DOWN" position.
- ... Put ignition switch into the "ACC" position.
- ... Wait for a long beep followed by a few short beeps. This may take up to one minute.
- ... Return programming switches to their default position (both switches "UP").
Wait up to 30 seconds for a confirmation beep.
- ... Put ignition switch into the "OFF" position.
- ... Wait at least 10 seconds.
- ... Put ignition switch into the "ACC" or "ON" position.
- ... Check MultiMediaLinQ for functionality, especially TEXT capabilities.

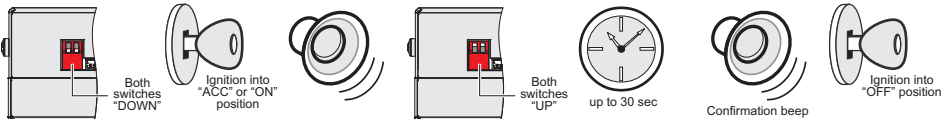

CD Changer Emulation Mode programming steps:

- ... Properly install VML player.
- ... Put "Right" programming switch in the "DOWN" position.
- ... Put ignition switch into the "ACC" position.
- ... Wait for a long beep followed by a few short beeps. This may take up to one minute.
- ... Return programming switches to their default position (both switches "UP").
Wait up to 30 seconds for a confirmation beep.
- ... Put ignition switch into the "OFF" position.
- ... Wait at least 10 seconds.
- ... Put ignition switch into the "ACC" or "ON" position.
- ... Check MultiMediaLinQ for functionality, especially TEXT capabilities.

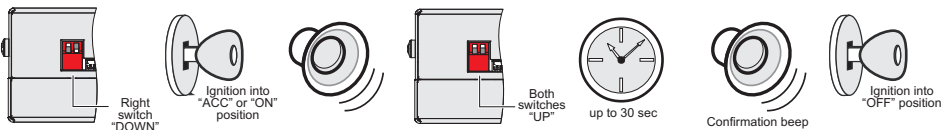

i IMPORTANT

- Improper Emulation Mode setting may cause this unit to be unrecognized by the head unit.
- CD or MD Changer Emulation Mode Programming MUST BE DONE in order for the unit to find the proper address location in the vehicle Audio/Video network.

CD-MP3 Emulation Mode Selection (CD-MP3 emulation)

CD-MP3 Emulation Mode programming steps:

- ... Properly install VML player.
- ... Put the "Left" programming switch in the "DOWN" position.
- ... Put ignition switch into the "ACC" position.
- ... Wait for a long beep followed by a few short beeps. This may take up to one minute.
- ... Return programming switches to their default position (both switches "UP").
Wait up to 30 seconds until confirmation beep.
- ... Put ignition switch into the "OFF" position.
- ... Wait at least 10 seconds.
- ... Put ignition switch into "ACC" or "ON" position.
- ... Check SoundLinQ for functionality, especially TEXT capabilities.

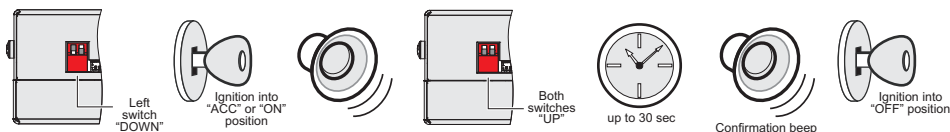

Mounting unit using Velcro fasteners

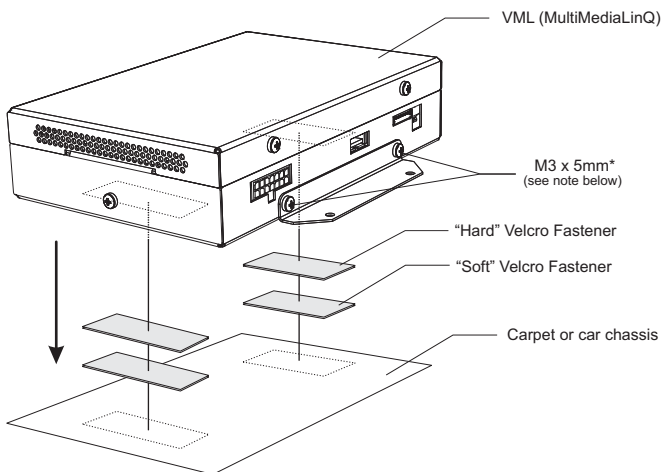

NOTE

- Velcro Fasteners are not included
- VAIS Technology strongly recommends grounding the unit to the car chassis for best results.
- Do not use any screws longer than 5mm. Using screws larger than 5mm may damage the PCB board.

WARNING

We strongly recommend to Ground VML to the vehicle's chassis



Hard Drive Installation/Removal

⚠ WARNING
Do not cover ventilation holes if you have hard drive installed

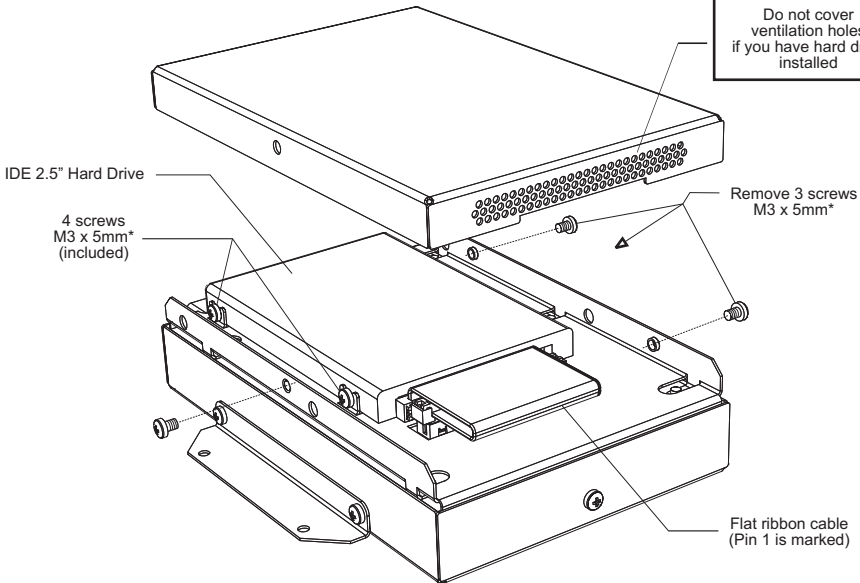

CAUTION
ELECTROSTATIC SENSITIVE DEVICES

i Internal Hard Drive Handling

- This unit can playback files from the optional internal IDE Hard Disc Drive (HDD).
- HDD playback functionality requires additional activation.
- HDD playback functionality will be automatically de-activated after 5 failed attempts to recognize HDD.
- Unit can recognize up to 4 Primary Partitions accessible as separate Discs.
- Depending on amount of files and specific file location, it may take considerable time before the file is played back.
- Never remove or hot-swap HDD while unit is powered to prevent possible damage of HDD and/or VML player itself.
- HDD must be formatted as FAT16 or FAT32.
- Unit can playback up to 999[●] playlists and up to 999 files in each playlist (per partition). Large amount of playlists and files can result in slow navigation and playback.
- For HDD VML player supports MPEG-1 Layer 1 (file extension .MP1), MPEG-1 Layer 2 (file extension .MP2) and the MPEG-2 audio extension to Lower Sampling Frequencies.
- File extensions must be used properly (non-audio data will not be recognized). Playback of non-audio data may generate a noise that can cause damage of amplifier and/or speakers.
- You must maintain "Free Space" on HDD necessary for unit operation (approximately 1% of partition capacity).
- Be sure HDD has enough free space to complete file transfer.
- Touching the connector terminals may transmit static electricity to the inner circuits of unit or HDD and may lead to malfunctions. Use precautions to prevent damage to the system by electrostatic discharge (ESD).
- To avoid condensation that can lead to HDD permanent damage do not introduce HDD or unit with HDD inside to sudden temperature changes. If transferring HDD or unit with HDD inside always allow it some time to adopt to the surrounding environment.
- Never touch top cover of HDD. Always hold HDD on the sides. Follow the Hard Drive Manufacturer handling instructions.
- Keep HDD or unit with HDD inside away from magnetic items.

 IMPORTANT**Important Please Read!**

(1) After a delay of five seconds, this product will automatically bypass the automobile manufacturer's on-screen warnings concerning use of the onboard navigation system. These warnings are: "Caution, Drive safely and obey traffic rules. Watching this screen while vehicle is in motion can lead to a serious accident. Make selections only while stopped. Some map data may be incorrect. Read safety instructions in Navigation Manual."

(2) PLEASE PRE-NOTIFY EVERY DRIVER OF THIS VEHICLE OF THE CONTENT OF THE AUTOMOBILE MANUFACTURER'S WARNING.

(3) IF YOU PREFER THAT THIS PRODUCT NOT ELIMINATE THE FOREGOING WARNINGS, YOU MAY DISABLE THIS FEATURE BY FOLLOWING THE INSTRUCTIONS IN THIS OWNER'S MANUAL, OR REFER TO INSTRUCTIONS AVAILABLE ON THE MANUFACTURER'S WEBSITE WWW.VAISTECH.COM.

Activate / Deactivate "I Agree" Automatic Bypass Function

- ▶ Put your device in Simple Mode by rapidly pressing the [SCAN] button 8 times (MUST BE DONE within 1-2 seconds).
- ▶ Push the DISC REPEAT button to hear a long beep to toggle the "I Agree" Automatic Bypass Function ON and OFF. (For vehicles not equipped with DISC REPEAT as a physical button, push and hold the REPEAT button until you hear a long beep to toggle the "I Agree" Automatic Bypass Function ON and OFF.

CD-MP3 Changer Emulation

Source Selection

Select desired source by pressing the **DISC** button on the head unit or **MODE** on the steering wheel control. (See diagram below)

Head Unit:

To switch between the unit sources you need to use “**DISC**” or “**CD**” button on the radio (Diagram below assumes factory CD changer is present).

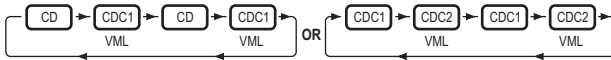

Steering Wheel control:

To switch between the unit and radio you need to use the “**MODE**” button on the steering wheel control. (Diagram below assumes following sources are present).

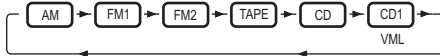

Functionality Description

Control of VML player is done through your head unit or the steering wheel controls (explained below).

This unit can be programmed in CD changer emulation mode, MD changer emulation mode and CD-MP3 Emulation. Please see attached chart to determine which emulation mode is compatible with your vehicle.

CD-MP3 changer emulation

For Radio Integrated into Navigation System
(5th Generation Navigation System)



List Of Folders (Playlists)



List Of Files (List of songs in selected Playlist)

This functionality is available for all 5th Gen Navigation system.

Please note all Toyota vehicles, except for Prius, do not have a list of files and folders display available on the screen due to Radio limitation.

Please also see “Activate / Deactivate ‘Disc Switching Fix’ Function”

CD-MP3 Changer Emulation

TRACK+ and **TRACK-**

Select the desired track

(Maximum number of tracks is 999 for CD-MP3 changer Emulation mode).

You can fast switch through tracks by repeatedly pressing the [TRACK+] / [TRACK-] button.

The track will change after a brief pause when you stop pressing the button.

NOTE: If a playlist only contains one track, the [TRACK+] / [TRACK-] buttons will not function.

FOLDER+ and **FOLDER-**

Select the desired playlist (Maximum number of playlists is 999).

You can fast switch through playlists by repeatedly pressing the [FOLDER+] / [FOLDER-] button.

The new playlist will start after a brief pause when you stop pressing the button.

NOTE: If there are no songs in a playlist the unit will jump to the next playlist.

FOLDER SCAN

Press and hold the RPT button to activate/disactivate playlist +50 mode. If "FOLDER SCAN" function are active use [FOLDER+] and [FOLDER-] as "Folder +50" and "Folder -50" to select the desired playlist

SCROLL UP and **SCROLL DOWN**

Fast Forward/Rewind the song

NOTE: For vehicle not equipped with [DISC+] and [DISC-] buttons, if "SCAN" function is active use [SCROLL UP] and [SCROLL DOWN] as [DISC+] and [DISC-] to select the desired playlist (in this case [DISC+] and [DISC-] will work as a [FOLDER+] and [FOLDER-])

RPT

Activates "Repeat One" function

FOLDER RPT

Press and hold the RPT button to activate playlist repeat. This mode will cause the current playlist to start over with the first track after the last track has been played, instead of moving on to the next playlist.

NOTE: Repeats all songs in active playlist.

RAND

The RAND button activates the playlist randomizer function. All tracks in the current playlist will be placed into a new, random order. The currently selected track will be renumbered to Track 1, and all subsequent tracks will be random selections from the playlist. After activating the playlist randomizer, the displayed track number does not map to the physical track number in the playlist, but rather to the new, randomized order.

NOTE: Shuffles all songs in the active playlist. VML player starts playing songs from your entire playlist in random order.

FOLDER LIST

The FOLDER LIST button will bring up a new display that allows you to scroll through the playlists and tracks on your VML player. [Folder Up] or [Folder Down] will scroll through playlists, while [File Up] or [File Down] will scroll through tracks.

If a playlist contains a large number of songs, it may take some time for the data to be transferred to the head unit.

This can cause the scroll buttons to become unresponsive during rapid scrolling, until data has been loaded from the VML player.

NOTE: Some vehicles' head units do not support the Folder/File display function. In this case when you press FOLDER you will see a blank display in the Folder and File lists.

DETAIL

Pressing the DETAIL button will bring up details on the current track. It will display Album Title, Track Title, and Artist. Genre is not supported and will always be blank.

NOTE: You can switch tracks while in DETAIL view, but it will not display the current track number.

CD-MP3 Changer Emulation**Category (Playlist, Artist, Album) Selection**

FLD. RAND

+

FOLDER+

and

FOLDER-

OR

FLD. RAND

+

DISC+

and

DISC-

Select the desired browsing category Playlist, Artist or Album ().

NOTE: If selected browsing category has playable files/songs in it, VML will start playing selected category. Otherwise VML will look for next available category. If no category is available to be selected, VML will continue to play current song.

NOTE: If any functions such as "REPEAT", "FOLDER REPEAT", "SCAN", "FOLDER SCAN" or "RANDOM" (if this function does not use the same button as a "FOLDER RANDOM") were active before you select "FOLDER RANDOM" VML will remember status of all these buttons, deactivate all of them for the time when "FOLDER RANDOM" is active. After "FOLDER RANDOM" is deactivated, all these functions will be restored automatically.

NOTE: For your convenience VML will automatically deactivate "FOLDER RANDOM" 15 seconds after you make selection for desired category. You can make selection for next available category during this 15 seconds and timeout timer will be reset to new 15 seconds.

CD/MD Changer Emulation

Source Selection

Select desired source by pressing **DISC** button on the head unit or **MODE** on the steering wheel control. (See diagram below)

Head Unit:

To switch between the unit sources you need to use "DISC" or "CD" button on the radio (Diagram below assumes factory CD changer is present).

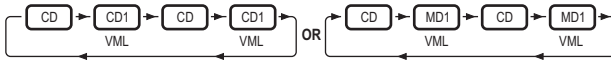

Steering Wheel control:

To switch between the unit and radio you need to use the "MODE" button on the steering wheel control. (Diagram below assumes following sources are present).

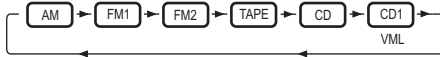

Functionality Description

Control of VML player is done through your head unit or the steering wheel controls (explained below).

This unit can be programmed in CD changer emulation mode, MD changer emulation mode and CD-MP3 Emulation. Please see attached chart to determine which emulation mode is compatible with your vehicle.

MD changer emulation

For Radio Receiver with LCD



CD changer emulation

For Radio Receiver with LCD



For Radio Integrated into Navigation System



VML
(Radio Integrated into Navigation System)
CD-Text support

For Radio Integrated into Navigation System



VML (Radio Integrated into Navigation System)
Direct Playlist selection
MAY NOT look/operate or be available on different year and model



Song Title, Artist Name or Album Name (see "DISC SCAN" function)
Playlist Title

Settings Mode

Enable/Disable “Settings mode”- press the [SCAN] button 8 times (**MUST BE DONE** within 1-2 seconds). You will hear a short beep.

The unit will not keep this mode in memory, after vehicle ignition is turned OFF and back ON, unit will return to normal mode.

Activate / Deactivate “I Agree” Automatic Bypass Function

... Put your device in Settings Mode by rapidly pressing the [SCAN] button 8 times (**MUST BE DONE** within 1-2 seconds).

... Push the DISC REPEAT button to hear a long beep to toggle the “I Agree” Automatic Bypass Function ON and OFF. (For vehicles not equipped with DISC REPEAT as a physical button, push and hold the REPEAT button until you hear a long beep to toggle the “I Agree” Automatic Bypass Function ON and OFF.

 IMPORTANT**Important Please Read!**

(1) After a delay of five seconds, this product will automatically bypass the automobile manufacturer's on-screen warnings concerning use of the onboard navigation system. These warnings are: "Caution, Drive safely and obey traffic rules. Watching this screen while vehicle is in motion can lead to a serious accident. Make selections only while stopped. Some map data may be incorrect. Read safety instructions in Navigation Manual."

(2) PLEASE PRE-NOTIFY EVERY DRIVER OF THIS VEHICLE OF THE CONTENT OF THE AUTOMOBILE MANUFACTURER'S WARNING.

(3) IF YOU PREFER THAT THIS PRODUCT NOT ELIMINATE THE FOREGOING WARNINGS, YOU MAY DISABLE THIS FEATURE BY FOLLOWING THE INSTRUCTIONS IN THIS OWNER'S MANUAL, OR REFER TO INSTRUCTIONS AVAILABLE ON THE MANUFACTURER'S WEBSITE WWW.VAISTECH.COM.

For CD-MP3 Changer Emulation ONLY!**Activate / Deactivate “Disc Switching Fix” Function**

“Disc switching Fix” has been designed to avoid a Radio malfunctioning in some vehicles while navigating through disc selection. VML comes with this feature activated by default, and it can causes screen to go black for 0.5 sec -1.5 sec in between disc selection. It doesn't have to be ON for all vehicles. Users are welcome to turn this feature OFF to determine whether or not it actually needs to be ON or OFF for their vehicles.

... Put your device in Settings Mode by rapidly pressing the [SCAN] button 8 times (**MUST BE DONE** within 1-2 seconds).

... Push the DISC RANDOM button to hear a long beep to toggle the “Disc Switching Fix” Function ON and OFF. (For vehicles not equipped with DISC RANDOM as a physical button, push and hold the RANDOM button until you hear a long beep to toggle the “Disc Switching Fix” Function ON and OFF.

CD/MD Changer Emulation

TRACK+ and **TRACK-**

Select the desired track

(Maximum number of tracks is 999 for CD changer and MD changer Emulation mode).

You can fast switch through tracks by repeatedly pressing the [TRACK+] / [TRACK-] button.

The track will change after a brief pause when you stop pressing the button.

NOTE: If a playlist only contains one track, the [TRACK+] / [TRACK-] buttons will not function.

NOTE: Due to the radio limitation in CD changer emulation VML will only displays two digits of the track number.

Track 100, 200, 300 .. 900 will be displayed as track "90", but text display for the track will contains "1^", "2^", "3^" ... "9^" for corresponding track "hundreds" at the beginning of the track title.

DISC+ and **DISC-**

Select the desired playlist (Maximum number of playlists is 99).

NOTE: Will be changed to 999 in the future Firmware.

You can fast switch through playlists by repeatedly pressing the [DISC+] / [DISC-] button.

The new playlist will start after a brief pause when you stop pressing the button.

NOTE: If there are no songs in a playlist the unit will jump to the next playlist.

SCROLL UP and **SCROLL DOWN**

Fast Forward/Rewind the song

DISC SCAN + **SCROLL UP** and **SCROLL DOWN**

NOTE: For vehicle not equipped with [DISC+] and [DISC-] buttons, if "DISC SCAN" function is active use [SCROLL UP] and [SCROLL DOWN] as [DISC+] and [DISC-] to select the desired playlist.

SCAN + **SCROLL UP** and **SCROLL DOWN**

NOTE: if "SCAN" function is active use [SCROLL UP] and [SCROLL DOWN] as "TRACK +10" and "TRACK -10" to select the desired song

RPT

Activates "Repeat One" function

DISC RPT

Activates "Repeat All" function.

NOTE: Repeats all songs in active playlist.

RAND

The RAND button activates the playlist randomizer function. All tracks in the current playlist will be placed into a new, random order. The currently selected track will be renumbered to Track 1, and all subsequent tracks will be random selections from the playlist. After activating the playlist randomizer, the displayed track number does not map to the physical track number in the playlist, but rather to the new, randomized order.

NOTE: Shuffles all songs in the active playlist. VML player starts playing songs from your entire playlist in random order.

DISC RAND + **RPT**

If "DISC RANDOM" function is active use "REPEAT" button to select the desired track title mode. You can choose between Song Title, Artist Name, or Album Name.

NOTE: If any functions such as "REPEAT", "DISC REPEAT", "SCAN", "DISC SCAN" or "RANDOM" (if this function does not use the same button as a "DISC RANDOM") were active before you select "DISC RANDOM" VML will remember status of all these buttons, deactivate all of them for the time when "DISC RANDOM" is active. After "DISC RANDOM" is deactivated, all these functions will be restored automatically.

NOTE: Track Title information can ONLY be displayed on Radio LCD or Navigation screen that support CD or MD changers with CD-Text or MD-Text.

CD/MD Changer Emulation**Category (Playlist, Artist, Album) Selection****DISC RAND** + **DISC+** and **DISC-**

Select the desired browsing category Playlist, Artist or Album.

NOTE: If selected browsing category has playable files/songs in it, VML will start playing selected category. Otherwise VML will look for next available category. If no category is available to be selected, VML will continue to play current song.

NOTE: If any functions such as "REPEAT", "DISC REPEAT", "SCAN", "DISC SCAN" or "RANDOM" (if this function does not use the same button as a "DISC RANDOM") were active before you select "DISC RANDOM" VML will remember status of all these buttons, deactivate all of them for the time when "DISC RANDOM" is active. After "DISC RANDOM" is deactivated, all these functions will be restored automatically.

NOTE: For your convenience VML will automatically deactivate "DISC RANDOM" 15 seconds after you make selection for desired category. You can make selection for next available category during this 15 seconds and timeout timer will be reset to new 15 seconds.

Disc "Partition" Selection**DISC RAND** + **SCAN** + **SCROLL UP** and **SCROLL DOWN**

NOTE: if "DISC RAND" and "SCAN" function are active use [SCROLL UP] and [SCROLL DOWN] to select desired DISC partition if available.

NOTE: For your convenience VML will automatically deactivate "DISC RANDOM" 15 seconds after you make selection for desired disc partition. You can make selection for next available disc partition during this 15 seconds and timeout timer will be reset to new 15 seconds.

i USB SECTION

USB Requirements	USB 1.1/ USB 2.0
Max. Power Consumption	750 mA
File System	FAT12/16/32
Number of Partitions	up to 4 Primary Partitions

i HDD SECTION

HDD Requirements	2.5" IDE automotive grade
Max. Power Consumption	5V 600 mA
File System	FAT12/16/32
Number of Partitions	up to 4 Primary Partitions

i GENERAL

Power Requirements	14.4 VDC (11-16 VDC allowable)
Power Consumption	<300 mA (without HDD and USB)
MP3	Bit rate: 8 kbps to 320 kbps Sampling frequency: 16 kHz to 48 kHz Compatible ID3 tag version: 1.0, 1.1, 2.2, 2.3, 2.4 (ID3 tag Version 2.x is given priority over Version 1.x.) M3u playlist: Supported MP3 PRO: Not supported
WAV	Compatible format: Linear PCM (LPCM) Quantization bits: 8, 16, 24 and 32 (LPCM) Sampling frequency: 16 kHz to 48 kHz (LPCM)
Frequency Response*	20-20,000 Hz (-0.53, +0.10)
Total Harmonic Distortion	0.005% (at 1kHz) if connected to CD/SAT port (12 pin Toyota/Lexus harness) 0.009% if connected directly to Amplifier (20 pin Lexus harness)
Dynamic Range	95 dB
Signal To Noise Ratio	94 dB
Stereo Crosstalk	88 dB (at 1kHz)
Operating ambient temperature	-40 to +85 °C (without HDD) -20 to +75 °C (with "rugged model" HDD) -30 to +85 °C (with "extreme model" HDD)
Chassis Size	
Width	159 mm (6-17/64")
Depth	108 mm (4-17/64") , without brackets
Height	32 mm (1-17/64")
Weight	0.51 kg (1 lbs. 2 oz) with brackets, but without HDD

Due to product improvement and modification, specifications are subject to change without notice

LICENSING AGREEMENT, DISCLAIMERS AND LIMITED WARRANTY

VAIS TECHNOLOGY, LTD

LICENSE AGREEMENT

VAIS TECHNOLOGY- SoundLinQ (SLU), (SLI), (SLX), (SLS), and SoundLinQ2 (SL2i), (SL2x), (SL2xmt), (SL2s) and MultiMediaLinQ (VML) for U.S.A. (hereinafter referred to as 'PRODUCT') and its related software For Most Toyota/Lexus Vehicles 2001-2009; (hereinafter collectively referred to as 'PRODUCTS'). THIS IS A LEGAL AGREEMENT BETWEEN YOU, AS THE END USER, AND VAIS TECHNOLOGY, LTD ("VAIS"). PLEASE CAREFULLY READ THE TERMS AND CONDITIONS OF THIS AGREEMENT BEFORE USING THE VAIS PRODUCTS. BY USING THE VAIS PRODUCTS AND SOFTWARE INSTALLED ON THE VAIS PRODUCTS, YOU ARE AGREEING TO BE BOUND BY THE TERMS OF THIS AGREEMENT. THE AUDIO INTERFACE CONTROLLER AND THE AUDIO VIDEO INTERFACE CONTROLLER ARE ESSENTIALLY THE BRIDGE BETWEEN A VEHICLE, ITS EQUIPMENT, AND ANY 'AFTER-MARKET' EQUIPMENT SUBSEQUENTLY ADDED TO THE VEHICLE BY THE END-USER. THE EQUIPMENT SOLD TO YOU, THE END USER, IF PROPERLY INSTALLED IS A RESETTABLE TECHNOLOGY, WHICH WILL, UNDER NORMAL CIRCUMSTANCES, AUTOMATICALLY DISCONNECT IN THE EVENT OF ANY MALFUNCTION. SINCE VAIS DOES NOT INSTALL THIS EQUIPMENT, VAIS DISCLAIMS ANY LIABILITY FOR IMPROPER INSTALLATION OF THE VAIS TECHNOLOGY OR THE 'AFTER-MARKET' EQUIPMENT (INPUTS). FURTHER, THE 'END USER' ACKNOWLEDGES THAT THE PRODUCT AND ITS SOFTWARE ARE NOT INHERENTLY DANGEROUS AND DO NOT PROVIDE ANY INHERENT RISKS AND THEREFORE POTENTIAL DAMAGES TO THE END-USER, OTHER THAN 'Fitness for its Purpose'. Some radio receiver models may cause you to experience some technical difficulties, if the product does not operate properly please contact technical department promptly at support@vaistech.com.

1. GRANT OF LICENSE

VAIS grants to you a non-transferable, non-exclusive license to use the PRODUCT and its software installed on the VAIS product (the "PRODUCTS") and the related documentation solely for your own personal use or for internal use by your business, only on such VAIS PRODUCTS. You shall not copy, reverse engineer, translate, port, modify or make derivative works of the Software contained in the PRODUCT. You shall not loan, rent, disclose, publish, sell, assign, lease, sublicense, market or otherwise transfer the Software in the PRODUCT or use it in any manner not expressly authorized by this agreement. You shall not derive or attempt to derive the source code or structure of all or any portion of the Software in the PRODUCT by reverse engineering, disassembly, recompilation, or any other means. You shall not use the Software in the PRODUCT to operate a service bureau or for any other use involving the processing of data for other persons or entities. VAIS and its licensor(s) shall retain all copyright, trade secret, patent and other proprietary ownership rights to the Software in the PRODUCT. The PRODUCTS are Copyrighted/ Patented and/or at various stages of Pending and **may not** be copied, even if modified or merged with other products. You shall not alter or remove any copyright notice or proprietary legend contained in or on the PRODUCTS. You may transfer all of your license rights in the Software or the PRODUCT, the related documentation and a copy of this License Agreement And Warranty to another party, provided that the party reads and agrees to accept the terms and conditions of this License Agreement And Warranty.

2. OPERATIONAL WARNING AND SAFETY INSTRUCTIONS.

IMPORTANT NOTICE: YOU SHOULD READ AND FAMILIARIZE YOURSELF THOROUGHLY WITH THE FOLLOWING INFORMATION PRIOR TO INSTALLING AND USING THE – SoundLinQ (SLU), (SLI), (SLX), (SLS), SoundLinQ2 (SL2i), (SL2x), (SL2xmt), (SL2s) and MultiMediaLinQ (VML) and its related software (THE "PRODUCTS").

IN ADDITION, YOU MUST CAREFULLY READ AND FOLLOW THE INSTALLATION SCHEMATICS/INSTRUCTIONS FOR THE PRODUCT AND THE VEHICLE IN WHICH IT IS BEING INSTALLED. FAILURE TO FOLLOW INSTALLATION INSTRUCTIONS MAY DAMAGE THE PRODUCT AND THE VEHICLE AND WILL VOID THE PRODUCT WARRANTY AND MAY VOID THE VEHICLE WARRANTY. (A copy of the installation schematics is included with the Product and can also be found on the VAIS TECHNOLOGY website at www.vaistech.com.)

FAILURE TO ABIDE BY THESE OPERATIONAL WARNINGS AND SAFETY INSTRUCTIONS COULD RESULT IN SERIOUS BODILY INJURY OR DEATH. IN ADDITION, FAILURE TO FOLLOW THESE INSTRUCTIONS MAY VOID THE PRODUCT WARRANTY AND COULD BECOME A BASIS FOR LIABILITY ON THE PART OF THE VEHICLE OPERATOR IN THE EVENT OF AN ACCIDENT WHICH RESULTS IN INJURY TO PERSONS OR PROPERTY. UNDER NO CIRCUMSTANCES WILL VAIS OR ITS IMMEDIATE AGENTS OR PRINCIPALS, BE LIABLE, FOR DAMAGES INCURRED TO THE PRODUCTS, THE VEHICLE OR ITS PASSENGERS, OR OTHER THIRD-PARTIES AS A RESULT OF FAILURE TO FOLLOW VAIS'S INSTALLATION INSTRUCTIONS.

A COPY OF THE 'OPERATIONAL WARNINGS AND SAFETY INSTRUCTIONS' IS TO BE KEPT WITH THE VEHICLE AT ALL TIMES.

3. DISCLAIMER AND LIMITATION OF WARRANTIES.

(A) EXCEPT AS OTHERWISE CONTAINED HEREIN, the PRODUCTS and related documentation are provided to you, "AS IS". IN NO EVENT SHALL VAIS BE LIABLE FOR ANY DAMAGES, CLAIM OR LOSS INCURRED BY YOU (INCLUDING WITHOUT LIMITATION, COMPENSATORY, INCIDENTAL, INDIRECT, SPECIAL, CONSEQUENTIAL, OR EXEMPLARY DAMAGES, LOST PROFITS, LOST SALES OR BUSINESS, EXPENDITURES, INVESTMENTS, OR COMMITMENTS IN CONNECTION WITH ANY BUSINESS, LOSS OF ANY GOODWILL, OR DAMAGES. THE TERM 'INCIDENTAL DAMAGES' REFERS TO THE EXPENSES OF TRANSPORTING THE PRODUCTS TO THE VAIS SERVICE CENTER, LOSS OF THE END-USERS [ORIGINAL PURCHASER'S] TIME, LOSS OF THE USE OF THE PRODUCT, BUS FARES, CAR RENTALS OR OTHER COSTS RELATED TO THE CARE AND CUSTODY OF THE PRODUCT. THE TERM 'CONSEQUENTIAL DAMAGES' REFERS TO THE COST OF REPAIRING OR REPLACING OTHER PROPERTY, WHICH IS DAMAGED WHEN THIS PRODUCT DOES NOT WORK PROPERLY.) RESULTING FROM THE USE OR INABILITY TO USE THE PRODUCTS, INCLUDING ANY DAMAGES INCURRED DUE TO THE NEGLIGENT OPERATION OF A MOTOR VEHICLE, IN CONJUNCTION WITH THE USE OF SAID PRODUCTS. THE END-USER ACKNOWLEDGES ITS RESPONSIBILITY FOR THE USE OF THE PRODUCT. THE ADDITION OF VAIS PRODUCTS AND ANY AFTER-MARKET EQUIPMENT MAY ENHANCE THE VALUE OF A VEHICLE OR CAUSE A THIRD-PARTY TO ILLEGALLY ATTEMPT TO REMOVE THE PRODUCTS AND AFTER-MARKET EQUIPMENT. VAIS DISCLAIMS ANY LIABILITY RELATED TO SUCH THEFT AND POTENTIAL DAMAGE TO PROPERTY. IT IS THE END-USERS RESPONSIBILITY TO PROTECT ITS OWN PROPERTY.

THE END-USER FURTHER ACKNOWLEDGES THAT THE OPERATION OF A MOTOR VEHICLE IS AN INHERENTLY DANGEROUS ACTIVITY, AND BY ITS USE OF VAIS'S PRODUCTS, ACKNOWLEDGES THAT THE PRODUCTS ARE REMOTELY RELATED TO SAID MOTOR VEHICLE OPERATION, AND THUS ANY DAMAGES CAUSED TO THE DRIVER OF THE VEHICLE, THE VEHICLE ITSELF OR ANY THIRD-PARTY AND ITS PROPERTY IS NOT THE RESPONSIBILITY OF VAIS, ITS AGENTS OR ITS PRINCIPALS AND IS THE SOLE RESPONSIBILITY OF THE DRIVER OF SAID VEHICLE.

YOU, THE END-USER, OR ANY OTHER DRIVER OF THE VEHICLE, IS SOLELY RESPONSIBLE FOR THE SAFE OPERATION OF THE VEHICLE AND THE SAFETY OF BOTH YOU AND THE PASSENGERS. FOR SAFETY PURPOSES, THE PRODUCT SHOULD NOT BE USED FOR THE DRIVER'S ENTERTAINMENT, WHILE THE VEHICLE IS BEING DRIVEN. SUCH USE COULD BE A DISTRACTION TO THE DRIVER, WHICH COULD CAUSE AN ACCIDENT LEADING TO SERIOUS INJURY OR DEATH. IF YOU, THE END-USER ALLOW ANOTHER PERSON TO USE THE VEHICLE, IT IS YOUR RESPONSIBILITY TO THOROUGHLY BRIEF THAT OTHER USER, ON THE SAFETY REQUIREMENTS FOR OPERATING THE VEHICLE AND THE PRODUCTS INSTALLED THEREIN.

(B) SAID DISCLAIMERS SHALL APPLY TO THE USE OF SAID PRODUCTS, EVEN IF VAIS HAS BEEN INFORMED OF, KNEW OF, OR SHOULD HAVE KNOWN OF THE LIKELIHOOD OF SUCH DAMAGES. THIS LIMITATION APPLIES TO ALL CAUSES OF ACTION IN THE AGGREGATE, INCLUDING WITHOUT LIMITATION: BREACH OF CONTRACT, BREACH OF WARRANTY, NEGLIGENCE, STRICT LIABILITY, MISREPRESENTATION AND OTHER TORTS. IF VAIS'S WARRANTY DISCLAIMER OR LIMITATION OF LIABILITY SET FORTH IN THIS AGREEMENT SHALL, OR FOR ANY REASON WHATSOEVER, BE HELD UNENFORCEABLE OR INAPPLICABLE, YOU AND ANY OTHER END USER AGREE THAT VAIS'S LIABILITY SHALL NOT EXCEED (50%) OF THE PRICE PAID FOR THE ENCLOSED VAIS PRODUCT.

Some states do not allow the exclusion or limitation of incidental or consequential damages, so the above limitation or exclusion may not apply to you. This Warranty Disclaimer and Limitation of Liability shall not be applicable to the extent that any federal, state or local law, which cannot be preempted, prohibits any provision of this Warranty.

(C) Some States/Provinces or other governmental jurisdictions (such as cities) may have laws that prohibit the operation of a video screen within the sight of the Driver. If you have purchased such a product, you should use the product only in locations where it is legal to do so, and if you do use the product, set up the screen only where it may be visible to passengers only. Although VAIS strongly recommends that Products not be used while the vehicle is in motion, it is your responsibility to determine whether the product can be used in any given location. Any use of the PRODUCTS where it is illegal to do so, may be used against you as evidence of negligence in the event of an auto accident or other traffic infraction.

4. THIRTY (30)- DAY MONEY BACK WARRANTY ONLY IF PURCHASED DIRECT FROM VAIS.

Any Product purchased directly from VAIS, referencing a **Return Authorization Number (RAN)** during the Thirty-(30) day period following shipment by VAIS, may be returned for a full refund of the purchase price actually paid, only if you have received damaged, defective or incorrectly shipped merchandise. The RAN number may be obtained from **VAIS's Customer Support at (720) 733-2348**, and is valid for only thirty- (30) days from its issuance. Said RAN must be noted on the outside of the returned PRODUCTS' packaging. The PRODUCTS must be returned in its original packaging, intact, without any evidence of tampering with the PRODUCTS or physical damage caused by the Customer (End-User).

WE WOULD STRONGLY RECOMMEND THAT THE ITEM BE SHIPPED INSURED, SINCE THE RISK OF LOSS DURING SHIPPING IS WITH THE END-USER. Re-stocking Fees may apply. Damage Fees if deemed caused by the End-User may apply. SHIPPING AND HANDLING OF THE END-USER IS NOT REFUNDABLE AND MUST BE PREPAID, FOR THIS WARRANTY TO BE APPLICABLE. END-USER SHALL ASSUME ALL RISK OF LOSS FOR THE SHIPPING OF THE PRODUCTS TO VAIS. **PLEASE ALLOW UP TO EIGHT (8) WEEKS FOR VAIS TO CREDIT YOUR ACCOUNT.**

5. LIMITED WARRANTY.

VAIS warrants that the PRODUCTS will be free from defects in materials and workmanship for a period of ONE (1) YEAR from the date of purchase. VAIS'S sole obligation under this warranty is to repair or replace at VAIS'S option, any PRODUCTS that VAIS shall have determined to be defective. Any replacement of parts, shall at the option of VAIS and at no additional charge to the end-user, be new or rebuilt/re-engineered replacement parts. Any replacement of PRODUCTS shall be with new or remanufactured equivalent PRODUCTS. The End-User is responsible for all shipping costs to VAIS, in connection with warranty service. VAIS will not be liable for any defects arising out of any modification of the PRODUCTS, or misuse, neglect, improper installation not in accordance with the specifications provided by VAIS, or if the product is used in violation of any applicable local, state or federal laws. It is the End Users responsibility to ascertain the existence and applicability of any local laws to the operation of the PRODUCTS, in any location where the PRODUCTS are being used. other causes beyond Seller's reasonable control.

A. WHO PERFORMS VAIS TECHNOLOGY'S WARRANTY COMPLIANCE.

VAIS Technology's professional technical department will perform VAIS warranty obligations.

B. WHAT YOU MUST DO.

To obtain warranty performance, you must take the PRODUCTS, or deliver the PRODUCTS freight prepaid, to a VAIS Technology Authorized Service Center. If shipped, the PRODUCTS must be packaged so that it is protected from possible shipping damage. VAIS Technology will ship the PRODUCTS to you when warranty performance is completed. VAIS Technology will pay for shipping the PRODUCTS to you, if the product was repaired under the warranty and the Product was received by the Service Center during the warranty period, in which case the Product will be returned to you freight prepaid by VAIS. You must present to the Service Center, or include with your shipment, a dealer's bill of sale, or other original evidence, showing the date and place of purchase and describing the Product purchased to establish warranty eligibility. Be sure to include your return address and a written description of the problem and a daytime telephone number where you can be reached should the need arise.

SHIP TO: VAIS Technology
13792 Compark Blvd., Unit #125
Englewood, CO
80112

ATTENTION: SERVICE DEPARTMENT

For your own protection, you should obtain a proof of delivery receipt. Return shipping (that is, shipping back to the customer following repair or replacement), will be paid by the Seller unless repair or replacement is determined not to be covered by the warranty.

C. WHAT THE WARRANTY DOES NOT COVER. VAIS shall have no liability or obligation to Purchaser with respect to any PRODUCTS requiring service during the warranty period which is subjected to any of the following: abuse, improper operation, negligence, accident, modification, improper connections, failure of the end-user to follow the operating procedures outlined both herein, and in any user's manual, attempted repair by non-qualified personnel, Company or Association; operation of the Product outside of the published environmental and electrical parameters, or if such Product's original identification (trademark, serial number) markings have been defaced, altered, or removed. VAIS excludes from warranty coverage Products which have not been sold by VAIS or an Authorized VAIS Dealer to the Purchaser. VAIS also excludes from warranty coverage Products sold outside of the United States. **All wires and connectors furnished with, or as part of the PRODUCTS is furnished "AS IS" (i.e., without any warranty of any kind), except where expressly provided otherwise in any documentation or license agreement furnished with the PRODUCTS.**

Other Items Not covered Pursuant to this Warranty:

1. Damage occurring during shipment of the product to VAIS for repair (claims must be presented to the carrier);
2. Any cost or expense related to the removal or reinstallation of the product;
3. Any Products which have been adjusted, altered or modified without VAIS's consent;
4. Any Products that has been determined to contain an excessive amount of dust or dirt and any product that contains any other contaminants including liquid or foreign objects.

REPAIR OR REPLACEMENT AS PROVIDED IN THIS WARRANTY IS THE PURCHASER'S EXCLUSIVE WARRANTY REMEDY. IMPLIED WARRANTIES, INCLUDING THE WARRANTIES OF MERCHANTABILITY AND OF FITNESS FOR A PARTICULAR PURPOSE, SHALL NOT EXTEND BEYOND THE DURATION OF THE APPLICABLE PARTS WARRANTY PERIOD AND NO PERSON, COMPANY OR ASSOCIATION (INCLUDING AUTHORIZED DEALERS) IS AUTHORIZED TO ASSUME FOR VAIS ANY OTHER LIABILITY IN CONNECTION WITH THE SALE OF THE PRODUCT.

D. ALL WARRANTIES EXPRESS OR IMPLIED, ARE HEREBY DISCLAIMED BY VAIS, AND ANY SUCH WARRANTY IS DEEMED VOID, IN THE EVENT THE END-USER ATTEMPTS TO MODIFY THE PRODUCT OR PRODUCTS IN ANY WAY.

In addition, some states, do not allow limitations on how long an implied warranty lasts or the exclusion or limitation of incidental or consequential damages, so the above limitations or exclusion may not apply to you. This warranty gives you specific legal rights and you may have other rights, which may vary, from state to state. **THE ABOVE WARRANTY TERMS AND CONDITIONS ARE VALID ONLY IN THE U.S.A.**

IMPORTANT STEPS TO SAFEGUARD YOUR DATA AND PROPERTY :

Be sure to remove all third-party after market equipment, options, alterations, and attachments not warranted by VAIS Technology before sending the Product to VAIS for warranty service. **VAIS IS NOT LIABLE FOR ANY LOSS OR DAMAGE TO THESE ITEMS.**

6. OTHER PROVISIONS:

A. INDEMNIFICATION OF VAIS, ITS AGENTS AND EMPLOYEES. By Purchasing, Installing and Using the Products, You, the End-User, agree to indemnify, defend and hold harmless, VAIS, and its Affiliates, Directors, Officers, Agents and Employees from any Liabilities, Damage, Loss, Claim and Expense (including reasonable Attorney's Fees) arising out of the installation and use of the Products.

B. GOVERNING LAW. THIS AGREEMENT, and all Purchases hereunder shall be governed by, and construed under the laws of the State of Colorado, without regard to conflicts of law rules. You agree that the Courts of Colorado shall have exclusive jurisdiction over the Parties, for all disputes. Venue shall lie exclusively in either: (i) Arapahoe County District Court; or the U.S. District Court, District of Colorado.

C. NOT FOR RESALE NOR EXPORT ASSURANCES. You, the End-User certifies and agrees that the Products are being Purchased for the End-Users own use, and not for resale. The End-User further agrees that he/she/it will not remove components from Product for resale, unless he/ she/ it becomes certified as an official dealer of VAIS and enters into the appropriate 'Distribution Agreements' required by VAIS technology. The End-User further agrees that neither the software, nor any other technical data received from VAIS, nor the direct Product thereof, will be exported outside the United States, except as authorized and as permitted by VAIS and in accordance with the laws and regulations of the United States. If the software or Products rightfully obtained by you outside of the United States, you agree that you will not export the Software, Products, nor other technical data, received from VAIS; except as authorized and as permitted by VAIS, and in accordance with the laws and regulations of the United States. VAIS and the End-User recognize that violation of these provisions will result in damages to VAIS, in a substantial amount, which is not easily determined. If these provision are violated, the End-User shall be liable to VAIS in the amount of \$100/day, as liquidated damages and not as a penalty, commencing with the first day in which the end-user violates this provision and ending on the day in which such Products or its parts are recovered by VAIS.

D. FORCE MAJEURE. VAIS Technology shall not be liable for any delay or failure in performance caused by or resulting from acts of God, fire, flood, storms, earthquakes, tornados, other acts of nature, any accidents, riots, wars, government intervention, embargoes, strikes, labor difficulties, equipment failures, or any other causes beyond the control of VAIS Technology. Quantities are subject to availability. In the event of shortage, VAIS Technology may allocate sales and deliveries in its sole discretion.

E. WAIVER. Failure of VAIS Technology to insist upon strict performance of any provisions hereof shall not be deemed a waiver of its right and remedies.

F. SEVERABILITY. In the event that any of the provisions, or portions thereof, of this Agreement are held to be unenforceable or invalid by any court or tribunal of competent jurisdiction, the validity and enforceability of the remaining provisions, or portions thereof, shall not be affected thereby, and effect shall be given to the intent manifested by the provisions, or portions thereof, held to be enforceable and valid.

G. CONSTRUCTION: Throughout this Agreement the singular shall include the plural, and the plural shall include the singular, and masculine shall include the feminine wherever the context so requires.

H. COMPETENCY OF THE PARTIES. Each party is legally competent and fully authorized to execute this Agreement.

I. OPPORTUNITY TO REVIEW AGREEMENT WITH COUNSEL OF PARTIES OWN CHOOSING. You, the End-User acknowledge that YOU have had every right to consult a licensed attorney, and have done so to the extent of your desires, prior to entering into this Agreement, and: (a) has fully and carefully read and considered this Agreement prior to its execution; (b) has been sent to, or has had the opportunity to be fully apprised by his or her attorney of the legal effect and meaning of this document and all of its terms and conditions; (c) has had the opportunity to make whatever investigation or inquiry he/she deems necessary or appropriate in connection with the subject matter of this Agreement; (d) has been afforded the opportunity to negotiate as to any and all terms of this Agreement; and (e) is executing this Agreement voluntarily, free from any undue influence, coercion, duress or fraud of any kind.

J. BINDING EFFECT: Upon execution, this Agreement shall be binding and fully enforceable, and shall inure to the benefit of the parties hereto, their successors, personal representatives and heirs.

K. NOTICES: All notices, as may be required by this Agreement, shall be sent to the respective parties at the addresses set forth below. Appropriate registered or certified mailing to the parties may modify the place of notice.

L. ENTIRE AGREEMENT. These terms and conditions constitute the entire and exclusive agreement between you, the End-User and VAIS Technology, concerning the Products, and your purchase hereunder, and supercede all statements or other agreements, whether oral or written, between you and VAIS Technology. No change in this Agreement shall be effective, unless agreed to in writing by both you, the end-user and VAIS.

IF YOU DO NOT AGREE WITH THESE TERMS, PLEASE RETURN THE VAIS PRODUCTS (INCLUDING THE SOFTWARE* AND ANY WRITTEN MATERIALS) IN ORIGINAL CONDITION, AND IN ORIGINAL PACKAGE (INCLUDING SHIPPING BOX, AND ALL PACKAGING BELONGINGS USED FOR SECURE SHIPPING) WITHIN FIVE (5) BUSINESS DAYS OF RECEIPT OF THE PRODUCTS, TO THE PLACE FROM WHICH YOU PURCHASED THEM, FOR A FULL REFUND OF THE PURCHASE PRICE OF THE VAIS PRODUCTS.

* VALID FOR SPECIFIC VAIS PRODUCTS ONLY